

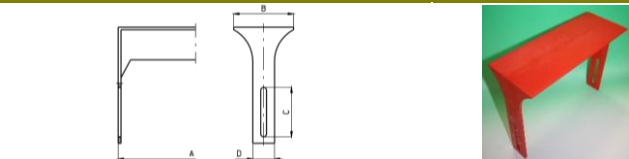

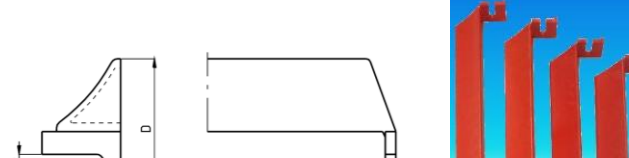

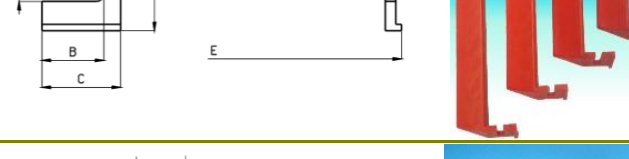





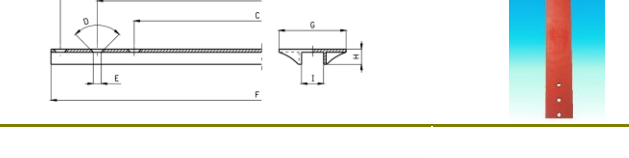
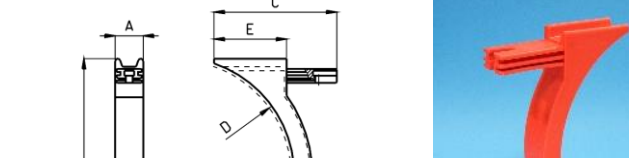
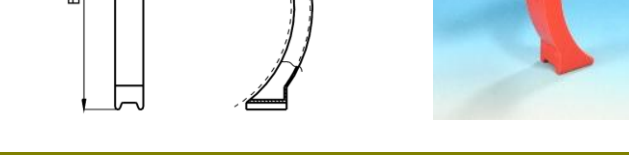
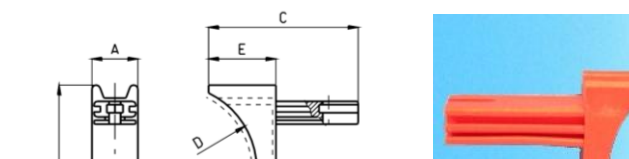
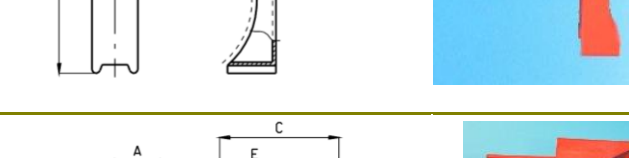
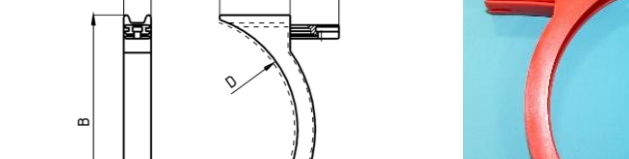
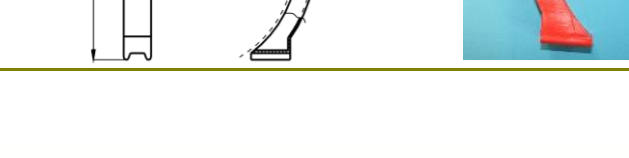

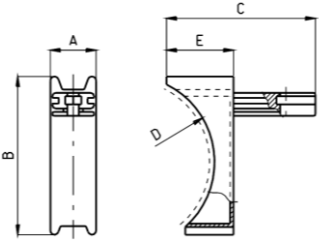

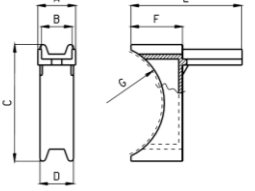

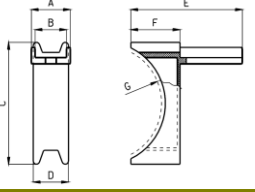

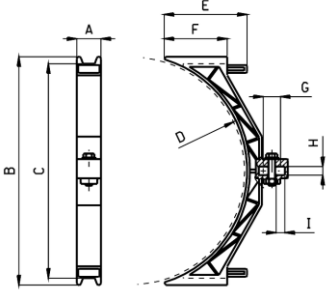

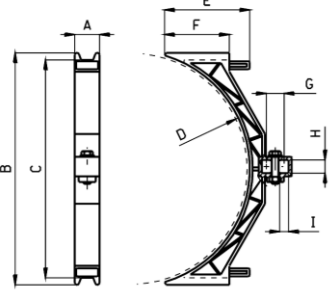

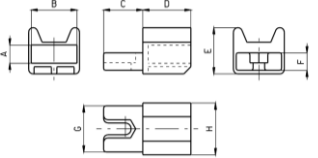

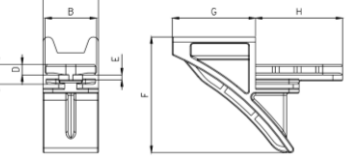

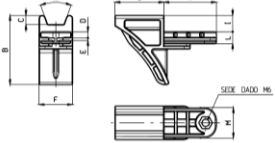

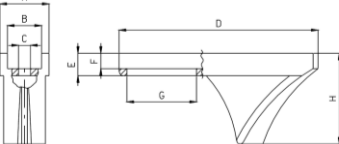

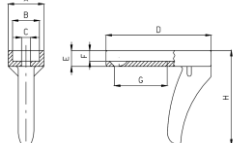

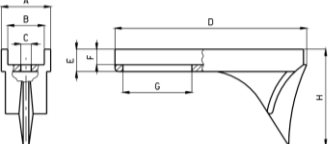

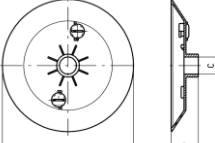

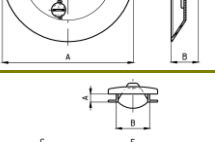

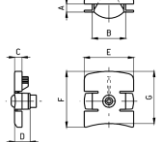

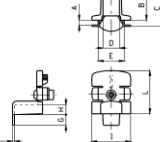

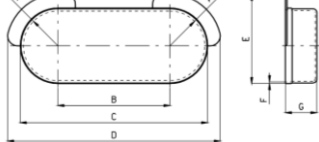

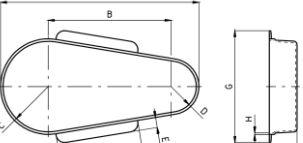

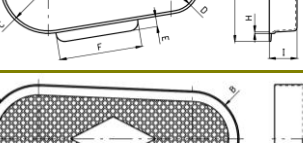
PARTI DI RICAMBIO PROTEZIONI ANTINFORTUNISTICHE PROTECTIONS AGAINST ACCIDENTS SPARE PARTS

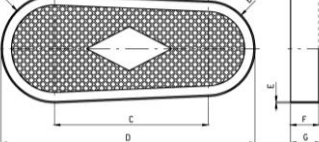
CODICE CODE	DESCRIZIONE DESCRIPTION	
SG060004004	Paramani Superiore per Telaio 500 Upper Handguard Frame 500 A=359mm B=109,3mm C=89,7mm D=39,6mm	
SG060004005	Paramani Superiore per Telaio 420 Upper Handguard Frame 420 A=281mm B=108,8mm C=89,7mm D=39,5mm	
SG060005001	Paramani Inferiore Telaio 420 Lower Handguard Frame 420 A=10,6mm B=43mm C=54,7mm D=97,8mm E=270mm	
SG060005002	Paramani Inferiore Telaio 500 Lower Handguard Frame 500 A=10,6mm B=43mm C=54,7mm D=97,8mm E=348mm	
SG060005005	Paramani Inferiore Telaio 600 Lower Handguard Frame 600 A=10,6mm B=43mm C=54,7mm D=97,8mm E=448mm	
SG060005006	Paramani Inferiore Telaio 700 Lower Handguard Frame 700 A=10,6mm B=43mm C=54,7mm D=97,8mm E=548mm	
SG060004006	Paramani Inferiore per Telaio 500 Lower Handguard Frame 500 A=88mm B=67,6mm C=29,7mm D=334,6mm	
SG060004007	Paramani Modulare x Telaio 500-600- 700 Modular Handguard for Frame 500-600- 700 A=542,9mm B=443,3mm C=343,5mm D=90° E=D11,2mm F=568mm G=90,3mm H=20mm I=29,6mm	
SG060010005	Protezione x Puleggia D.220 (PAU) Guard for Pulley D.220 (PAU) A=28mm B=228mm C=125mm D=D220mm E=76mm	
SG060010006	Protezione x Puleggia D.230 (PAU) Guard for Pulley D.230 (PAU) A=28mm B=239mm C=125mm D=D230mm E=76mm	
SG060010007	Protezione x Puleggia D.240 (PAU) Guard for Pulley D.240 (PAU) A=28mm B=248mm C=125mm D=D240mm E=76mm	
SG060010008	Protezione x Puleggia D.250 (PAU) Guard for Pulley D.250 (PAU) A=28mm B=257mm C=125mm D=D250mm E=76mm	
SG060010010	Protezione x Puleggia D.170 (PAU) Guard for Pulley D.170 (PAU) A=28mm B=180mm C=105mm D=D170mm E=56mm	
SG060010001	PROTEZIONE x PULEGGIA D. 60 (PAU) GUARD FOR PULLEY D.60 (PAU) A=28mm B=52,5mm C=73mm D=D60mm E=24mm	
SG060010002	Protezione x Puleggia D. 80 (PAU) Guard for Pulley D.80 (PAU) A=28mm B=96,5mm C=93mm D=D80mm E=43mm	
SG060010003	Protezione x Puleggia D.100 (PAU) Guard for Pulley D.100 (PAU) A=28mm B=102,5mm C=93mm D=D100mm E=43mm	
SG060010009	Protezione x Puleggia D.120 (PAU) Guard for Pulley D.120 (PAU) A=28mm B=129,5mm C=99mm D=D120mm E=49mm	
SG060010105	Protezione x Puleggia D.220 (GTC) Guard for Pulley D.220 (GTC) A=28mm B=228mm C=125mm D=D220mm E=76mm	
SG060010106	Protezione x Puleggia D.230 (GTC) Guard for Pulley D.230 (GTC) A=28mm B=239mm C=125mm D=D230mm E=76mm	
SG060010107	Protezione x Puleggia D.240 (GTC) Guard for Pulley D.240 (GTC) A=28mm B=248mm C=125mm D=D240mm E=76mm	
SG060010108	Protezione x Puleggia D.250 (GTC) Guard for Pulley D.250 (GTC) A=28mm B=257mm C=125mm D=D250mm E=76mm	

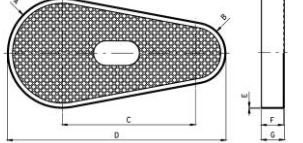
SG060010110	Protezione x Puleggia D.170 (GTC-18 0) Guard for Pulley D.170 (GTC-18 0) A=28mm B=180mm C=105mm D=D170mm E=56mm		
SG060010101	PROTEZIONE x PULEGGIA D. 60 (GTC) GUARD FOR PULLEY D.60 (GTC) A=28mm B=52,5mm C=73mm D=D60mm E=24mm		
SG060010102	Protezione x Puleggia D. 80 (GTC) Guard for Pulley D.80 (GTC) A=28mm B=96,5mm C=93mm D=D80mm E=43mm		
SG060010103	Protezione x Puleggia D.100 (GTC) Guard for Pulley D.100 (GTC) A=28mm B=102,5mm C=93mm D=D100mm E=43mm		
SG060010109	Protezione x Puleggia D.120 (GTC) Guard for Pulley D.120 (GTC) A=28mm B=129,5mm C=99mm D=D120mm E=49mm		
SG060010202	Protezione x Puleggia D.80 Gola "C" (U 25-12) Guard for Pulley D.80 "C" Groove (U 25-12) A=31,5mm B=25,5mm C=96,5mm D=28mm E=93mm F=43mm G=80mm		
SG060010203	Protezione x Puleggia D.100 Gola "C" (U 25-12) Guard for Pulley D.100 "C" Groove (U 25-12) A=31,5mm B=25,5mm C=96,5mm D=28mm E=93mm F=43mm G=100mm		
SG060010204	Protezione x Puleggia D.170 Gola "C" (U 25-12) Guard for Pulley D.170 "C" Groove (U 25-12) A=32mm B=25,5mm C=166,5mm D=28mm E=105mm F=56mm G=D170mm		
SG060003009	Protezione Integrale per Puleggia D.170 Trafilato 10x10 Complete Protection for Pulley D.170 Slot=10X10 A=28mm B=180mm C=163mm D=D170mm E=81mm F=59mm G=20mm H=10mm I=10mm		
SG060003011	Protezione Integrale per Puleggia D.230 Trafilato 10x10 Complete Protection for Pulley D.230 Slot=10X10 A=28mm B=243mm C=226mm D=D230mm E=89mm F=67mm G=20mm H=10mm I=10mm		
SG060003013	Protezione Integrale per Puleggia D.250 Trafilato 10x10 Complete Protection for Pulley D.250 Slot=10X10 A=28mm B=263mm C=247mm D=D250mm E=95,5mm F=73mm G=20mm H=10mm I=10mm		
SG060003015	Protezione Integrale X Puleggia D.170 Trafilato 10x15 Complete Protection for Pulley D.170 Slot=10X15 A=28mm B=180mm C=163mm D=D170mm E=81mm F=59mm G=20mm H=15mm I=10mm		
SG060003017	Protezione Integrale X Puleggia D.230 Trafilato 10x15 Complete Protection for Pulley D.230 Slot=10X15 A=28mm B=243mm C=226mm D=D230mm E=89mm F=67mm G=20mm H=15mm I=10mm		
SG060003019	Protezione Integrale X Puleggia D.250 Trafilato 10x15 Complete Protection for Pulley D.250 Slot=10X15 A=28mm B=263mm C=247mm D=D250mm E=95,5mm F=73mm G=20mm H=15mm I=10mm		
SG060003022	Adattatore per Protezione Integrale Gola "B" e "C" Adapter for Complete Protection "B" and "C" Groove A=10mm B=25,7mm C=22mm D=27mm E=25,5mm F=9,6mm G=25,5mm H=28,5mm		
SG060011001C0	Salvadita Puleggia D.250 Gola "C" (PAU-GTC) (pack300) Finger Guard for Pulley D.250 "C" Groove (PAU-GTC) (pack300) A=28mm B=26mm C=10mm D=5,3mm E=2mm F=58mm G=42mm H=44mm		

SG060011002C0	<p>Salvadita Puleggia D.170 Gola "C" (PAU-GTC) (pack300) Finger Guard for Pulley D.170 "C" Groove (PAU-GTC) (pack300) A=40° B=58mm C=7,7mm D=5,3mm E=2mm F=28mm G=41mm H=44mm I=13,8mm L=10mm M=25,5mm</p>		
SG060003002C0	<p>Salvadita Puleggia D.250 (pack100) Finger Guard for Pulley D.250 (pack100) A=34,7mm B=24mm C=8,5mm D=140,5mm E=15,9mm F=10,9mm G=49,1mm H=64mm</p>		
SG060003001C0	<p>Salvadita Puleggia D.170 (pack100) Finger Guard for Pulley D.170 (pack100) A=34,3mm B=25,9mm C=8,7mm D=100mm E=15,1mm F=10,2mm G=50,6mm H=89,7mm</p>		
SG060003003C0	<p>Salvadita Puleggia D.125 (pack100) Finger Guard for Pulley D.125 (pack100) A=34,3mm B=25,8mm C=7,4mm D=135,7mm E=15,7mm F=10,9mm G=48,8mm H=68,3mm</p>		
SG060006001	<p>Copripuleggia in 2 pz D.290 Pulley Cover in Two Parts D.290 A=272,1mm B=46,2mm C=D30mm</p>		
SG060006002	<p>Copripuleggia in 2 pz D.240 Pulley cover in Two Parts D.240 A=231mm B=47,8mm C=D30mm</p>		
SG060006004/1	<p>Tappo per Asola Puleggia Folle Plug for Idler Pulley A=5,2mm B=27,5mm C=6mm D=12,7mm E=40mm F=45mm G=41,5mm</p>		
SG060006005/1	<p>Tappo per Asola Puleggia Traino Plug for Driving Pulley A=5,5mm B=30,5mm C=37,6mm D=17,5mm E=28,5mm F=2mm G=11,9mm H=10,5mm I=10,5mm L=40mm L=44mm</p>		
SG060001003	<p>Carter di Protezione Piccolo Small Protective Case A=87,5mm B=284mm C=473mm D=536mm E=224mm F=4,6mm G=83mm</p>		
SG060001001	<p>Carter di Protezione Grande Big Protective Case A=680mm B=452,5mm C=135mm D=77,5mm E=33mm F=250mm G=341mm H=4,5mm I=82,3mm</p>		
SG060001002	<p>Carter di Protezione Medio Medium Protective Case A=587mm B=363,5mm C=133,5mm D=75mm E=30mm F=245mm G=339mm H=4,5mm I=81,5mm</p>		
SG060001005	<p>Carter di Protezione ART.29 Protective Case W/Grating ART.29 A=D150mm B=D132mm C=432mm D=714mm E=3mm F=79,4mm G=84,9mm</p>		
SG060001004	<p>Carter di Protezione ART.28 Protective Case W/Grating ART.28 A=D179,5mm B=D100mm C=435,5mm D=715mm E=3,2mm F=71,4mm G=74,8mm</p>		

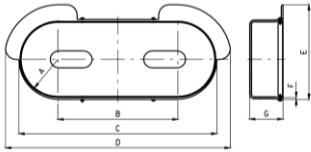
SG060002003/1	Protezione x Carter Piccolo Con Viti Verniciata Nero RAL 9005/SML Internal Protection for Small Case With Screws A=D150mm B=D132mm C=432mm D=714mm E=3mm F=79,4mm G=84,9mm		
SG060002001/1	Protezione x Carter Grande Con Viti Big Internal Protection W/Screws A=454mm B=137mm C=80mm D=40mm E=100mm F=292,7mm G=671mm H=12mm I=1,4mm		
SG060002002/1	Protezione x Carter Medio Con Viti Medium Internal Protection W/Screws A=362mm B=136mm C=76mm D=40mm E=100mm F=203,5mm G=574mm H=12mm I=1,4mm		
SG060002005/1	Protezione x Carter ART.29 C/Viti Internal Protection W/Screws ART.29 A=429mm B=148mm C=132mm D=40mm E=100mm F=271mm G=709mm H=11,8mm I=1,4mm		
SG060002004/1	Protezione x Carter ART.28 C/Viti Internal Protection for Case W/Screws A=429mm B=148mm C=132mm D=40mm E=100mm F=271mm G=709mm H=11,8mm I=1,4mm		
SG060001007	Carter Protezione Mole DX Right Protection Case A=123mm B=65,6mm C=177,8mm D=D72mm E=295,5mm F=26,1mm G=6mm H=80,8mm I=87,2mm		
SG060001008	Carter Protezione Mole SX Left Protection Case A=123mm B=65,6mm C=177,8mm D=D72mm E=295,5mm F=26,1mm G=6mm H=80,8mm I=87,2mm		
SG060007001	Anello Conico per Cabina D.65 Conic Ring for Cabin D.65 A=D111,5mm B=45° C=D65,3mm D=D22,7mm		
SG060007002	Anello Conico per Cabina D.60 Conic Ring for Cabin D.60 A=D111,8mm B=45° C=D59,6mm D=D22,2mm		
SG060008001 /AC0	Protezione per Supp.UCP 206 (pack100) Protection for UCP Support (pack 100) A=35mm B=39mm C=171mm D=66,7mm E=105,5mm F=73mm		
SG060008001 /AC1	Protezione per Supp.UCP 206 (pack600) Protection for UCP Support (pack 600) A=35mm B=39mm C=171mm D=66,7mm E=105,5mm F=73mm		
SG060008001/B	Piastrina per Protez.Supp.UCP 206 F .30 Protection Plate for UCP 206 Hole 30 A=66mm B=D30,4mm C=45,5mm D=D6mm		
SG060008001/C	Piastrina per Protez.Supp.UCP 206 F.35 Protection Plate for UCP 206 Hole 35 A=65,3mm B=D34mm C=45,5mm D=D6mm		
SG060008003C0	Protezione per Supporto UCP 206 A30 Protection for UCP 206 Support SH.30 (pack 100) A=34,8mm B=30mm C=171mm D=65,8mm E=73mm F=105,5mm		
SG060008003C1	Protezione per Supporto UCP 206 A30 Protection for UCP 206 Support SH.30 (pack 600) A=34,8mm B=30mm C=171mm D=65,8mm E=73mm F=105,5mm		
SG060008004C0	Protezione per Supporto UCP 206 A35 Protection for UCP 206 Support SH.35 (pack 100) A=34,8mm B=35mm C=171mm D=65,8mm E=73mm F=105,5mm		
SG060008004C1	Protezione per Supporto UCP 206 A35 Protection for UCP 206 Support SH.35 (pack 600) A=34,8mm B=35mm C=171mm D=65,8mm E=73mm F=105,5mm		

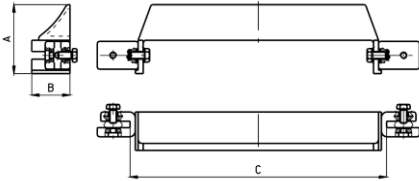
SG160004001	Carter Piccolo con Protezione Interna Montata Small Case W/Internal Protection (Assembled) A=87,5mm B=284mm C=473mm D=536mm E=224mm F=4,6mm G=83mm		
SG060005007	Paramani Inf. Completo X Tel 600 Complete Lower Handguard FR.600 A=97,8mm B=54,7mm C=466mm		
SG060005009	Paramani Inf. Completo X Tel 600 (N.4 Viti M10x20) Complete Lower Handguard FR. 600 A=97,8mm B=54,7mm C=466mm		
SG060005010	Paramani Inf. Completo X Tel 500 (N.4 Viti M10x20) Complete Lower Handguard FR.500 A=97,8mm B=54,7mm C=366mm		
SG060005011	Paramani Inf. Completo X Tel 700 (N.4 Viti M10x20) Complete Lower Handguard FR.700 A=97,8mm B=54,7mm C=566mm		